

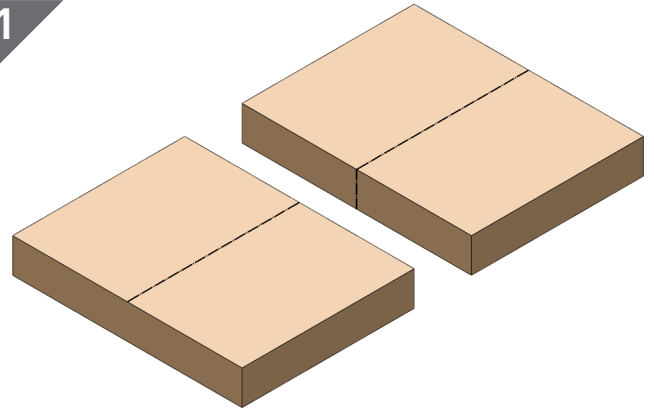

## Flush Mounting

1



Position 2 surfaces tight together into position, mark out a centreline on both surfaces.

|               |                                |
|---------------|--------------------------------|
| Material      | High Strength Reinforced Nylon |
| Colour        | Black or White                 |
| Fixing Method | 8G Screws (6x) or Euro screw   |

2

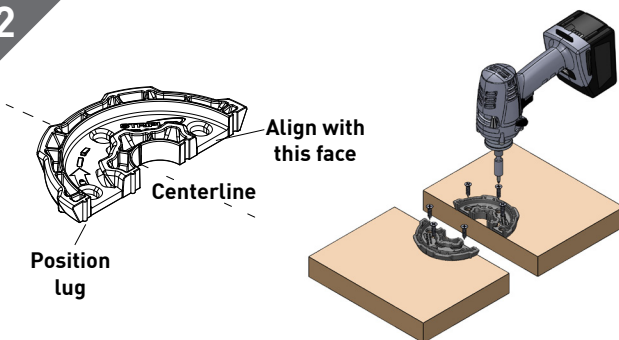

Position 1st half of 180D flush with edge of substrate (note position lug will be slightly proud) ensure main face is flush across the full edge using centreline position and screw into position.

3

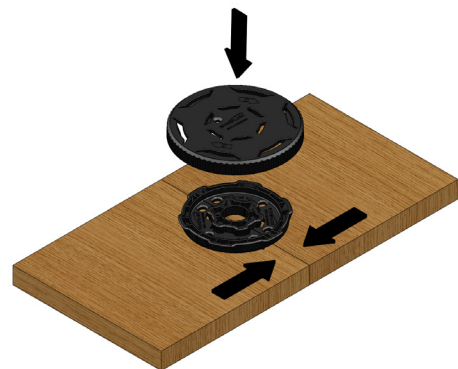

Push the two faces together. Lining up the male and female lugs on the face of the hooks. Place the locking key over the two hooks and push down into position.

4

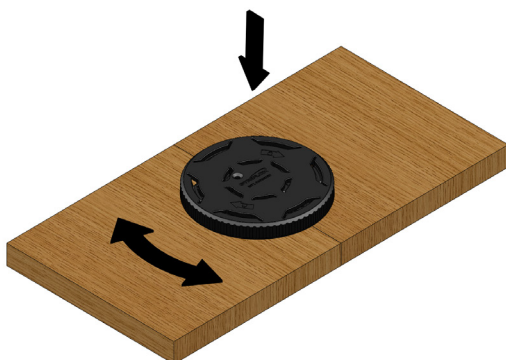

To join together turn the key as shown. NOTE: There is no locking tab to remove. When you turn in either direction you will feel resistance as locking key tightens. Locked position is when align locking screw position.

5

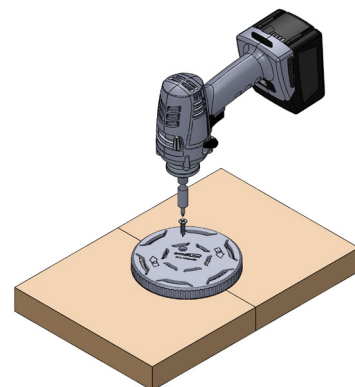

For permanent lockup use a screw position in key ensuring enough embedment into substrate.

## Recess Mounting (flush)

1

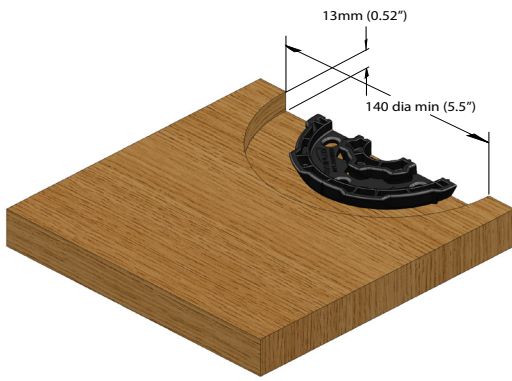

2

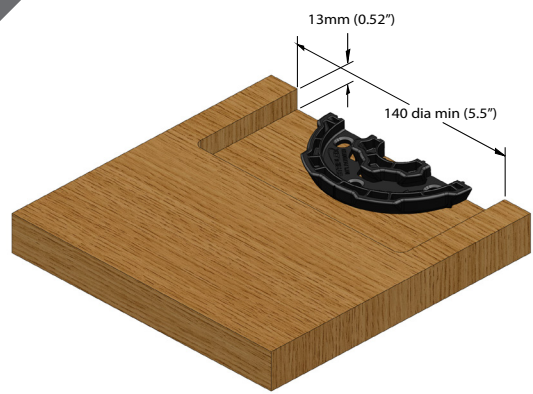

Router position at centrelines into 2 surfaces at current depth 13mm (0.52"), either circular or square cut ensure sufficient clearance for key to lock down and turn.

## Installation Aid

3

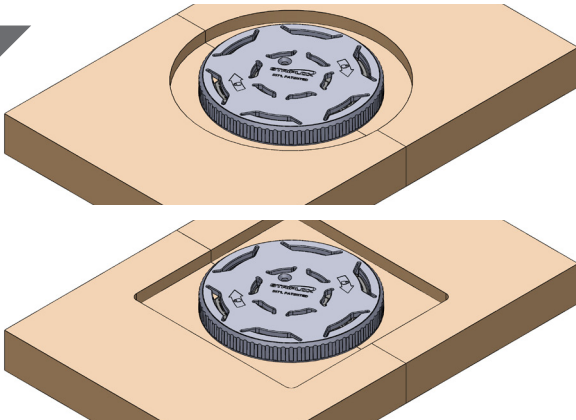

Ensure sufficient space to turn and remove locking key.

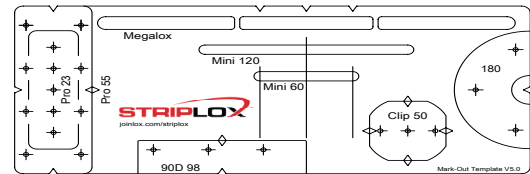

### Striplox Mark-Out Template

Developed to aid in the installation of all Striplox products..

## Dimensions and Load Capacity

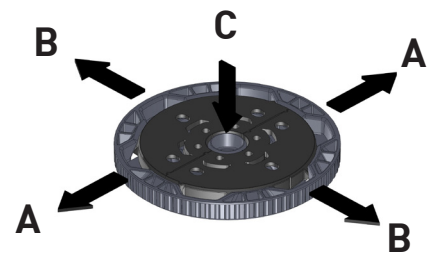
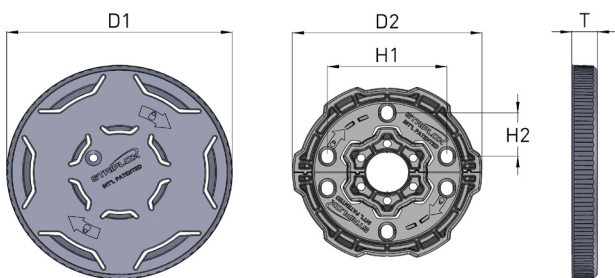

### Dimensions

### Ind. Load Capacity

| Units             | D1    | D2   | H1   | H2   | T    |  | A   | B   | C   |
|-------------------|-------|------|------|------|------|--|-----|-----|-----|
| Metric (mm/kg)    | 114.3 | 96   | 60.5 | 23.3 | 13   |  | 200 | 200 | 230 |
| Imperial (in/lbs) | 4.5   | 3.78 | 2.38 | 0.92 | 0.51 |  | 440 | 440 | 507 |

Striplox products are designed and tested for a range of applications. Product use is subject to variable materials and conditions. Technical information and load ratings are a guide only without warranty. Joinlox will not be liable for any subsequent damage to, or loss from, the use of this product or this information.

Visit [www.striplox.com](http://www.striplox.com) YOU TUBE V=8maZy-ywO8o or call 1800 JOINLOX to find out more about these installation aids.

Striplox™ and Joinlox® are trademark and patent protected internationally.

Installation Guide 180D V1.0 06.08.18